

# Paisley Corridor Resignalling

## Stage 2

Cardonald (SC059 Ayr Lines) Elderslie West

Arkleston East (SC065 Gourock Lines) Port Glasgow



# Contents

## Legend

Page 3

Page 4

## Route Cardonald – Elderslie West / Arkleston East – Port Glasgow

Page 5 Cardonald

Page 6 Hillington East/Cardonald North

Page 7 Hillington West

Page 8 Arkleston East

Page 9 Arkleston West

Page 10 MP 6

Page 11 Wallneuk Junction

Page 12 Paisley Gilmour Street

Page 13 MP.8 / Paisley St.James

Page 14 Elderslie East / MPs.109-110

Page 15 Elderslie West / MPs.111-112

Page 16 Bishopton

Page 17 Langbank

Page 18 Woodhall

Page 19 Port Glasgow

## Tables of Routes Down

Page 20

## Tables of Routes Up

Page 22

# Legend

## Colour Light Signals

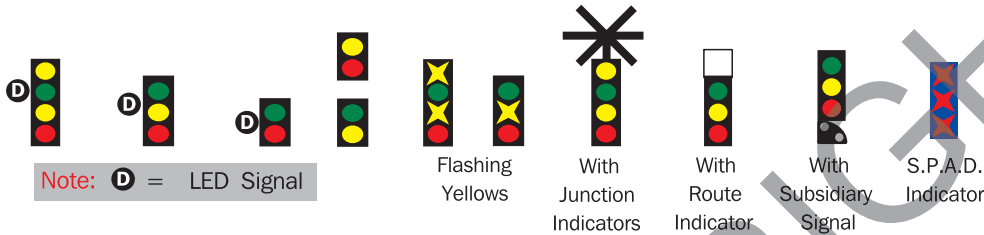

## Semaphore Signals



## Shunting Signals

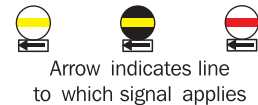

## Ground Position Light Signals

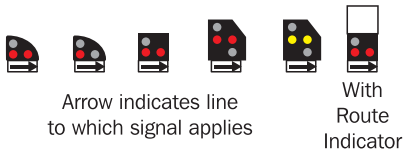

## Banner Repeaters



## Stop Boards



## Limit of Shunt Indicators



## Signal Plates

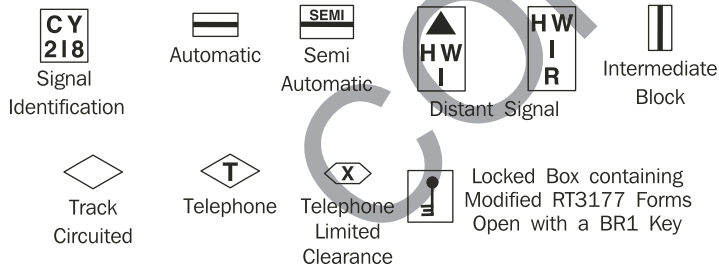

## Radio Electric Token Block Signals

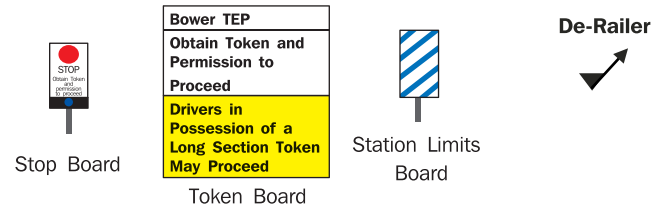

# Legend

## General Information

Running Lines showing direction of travel

Signal Box

Ground Frame

Ground Switch Panel

Gradient Board 100 Level

(All grades 1 in xx)

Countdown Markers

Mile Post

Telephone

Shut in Facility

Limited Clearance

Warning

St. Andrews Cross

Carriage Washer

Area of Known Low Adhesion

End of Area of Low Adhesion

Area of Known Trespass or Vandalism

Tunnel

Affected by Sun

Location where Drivers Reminder Appliance Board Provided

Viaduct

Over Bridge

Footbridge

Level Crossing

Footpath

Retaining Wall

Left Right

Indicator

Right Away Indicator

Close Doors Indicator

Sand Drag

## Permanent Speed Restrictions

Start of Area

End of Area

Advance

Start

Diverging Route

Cab Secure Radio Area

National Radio Network Area

Start of GSMR (IVRS) Area

End of GSMR (IVRS) Area

Electrified Lines

Buffer Stops

Start of High Fire Risk Area

End of High Fire Risk Area

DA Down Ayr  
 UA Up Ayr  
 UG Up Gourock  
 DD Down Deanside  
 UD Up Deanside

Note: **D** = LED Head Signal

\* = See Table of Routes

TCB  
 West of Scotland SC (GS)  
 AC: Cathcart ECR

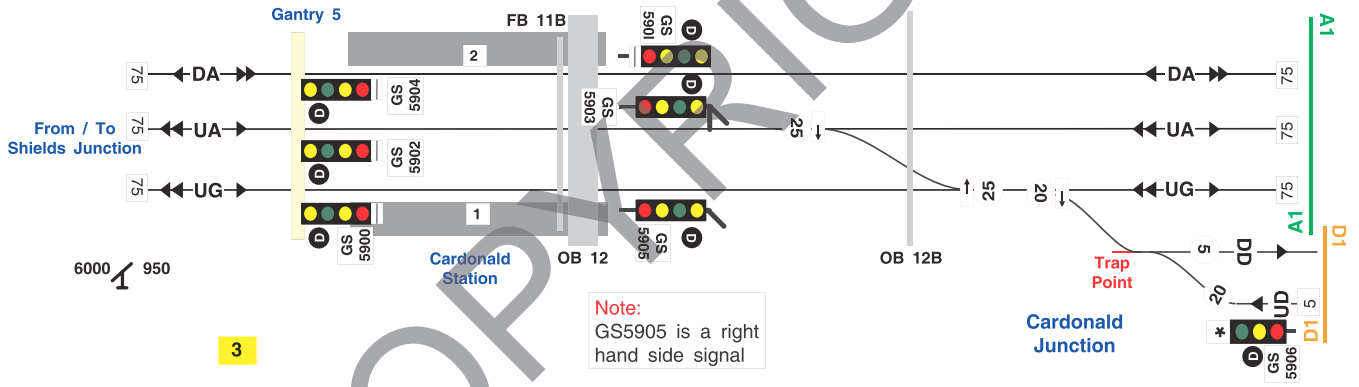
DA Down Ayr  
 UA Up Ayr  
 UG Up Gourock  
 DD Down Deanside  
 UD Up Deanside

Note: **D** = LED Head Signal

TCB  
 West of Scotland SC (GS)  
 AC: Cathcart ECR

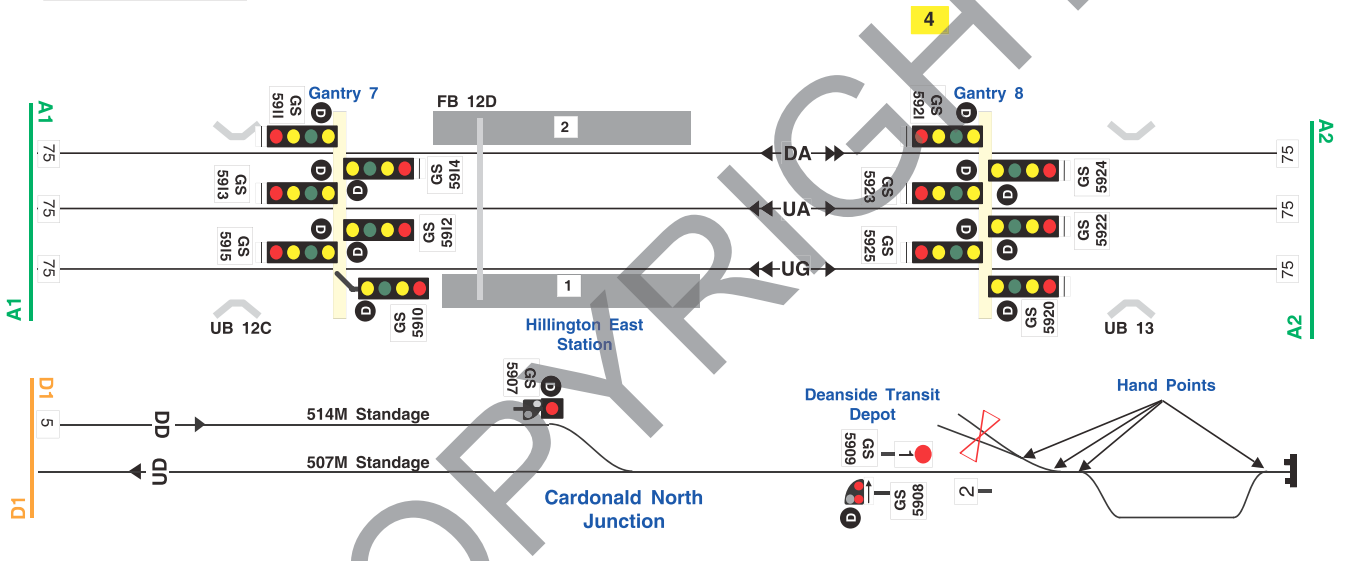

**Signs Read :-**  
 1:- COMMENCEMENT OF YARD WORKING "BEWARE OF CONFLICTING MOVEMENTS BEFORE PROCEEDING"  
 2:- J G RUSSELL LOCOS MUST NOT PROCEED BEYOND THIS NOTICEBOARD WITHOUT PERMISSION

**DA** Down Ayr  
**UA** Up Ayr  
**UG** Up Gourock

**Note:** **D** = LED Head Signal

**TCB**  
 West of Scotland SC (GP)  
 AC: Cathcart ECR

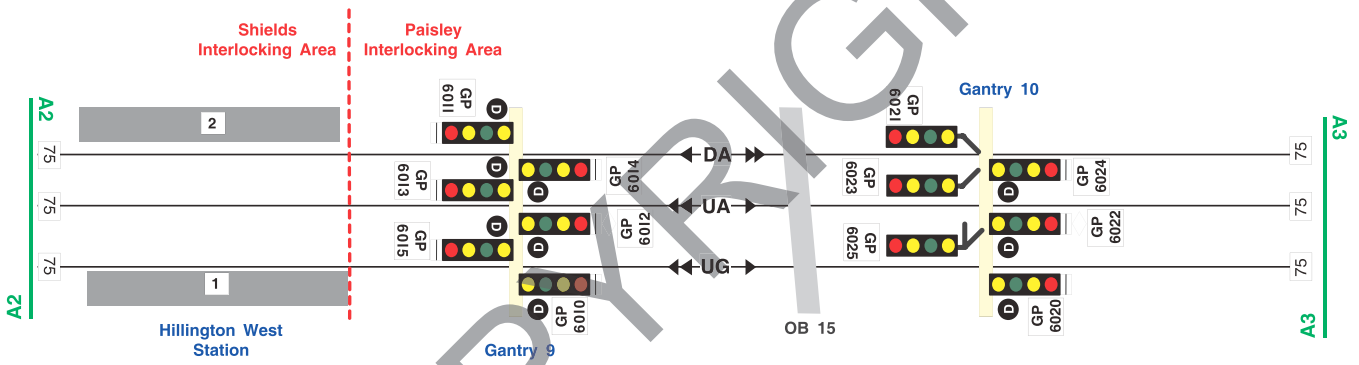

- DA Down Ayr
- UA Up Ayr
- DG Down Gourock
- UG Up Gourock
- CL Connecting Line

Note: **D** = LED Head Signal  
 \* = See Table of Routes

TCB  
 West of Scotland SC (GP)  
 AC: Cathcart ECR



950 ↑ 7000

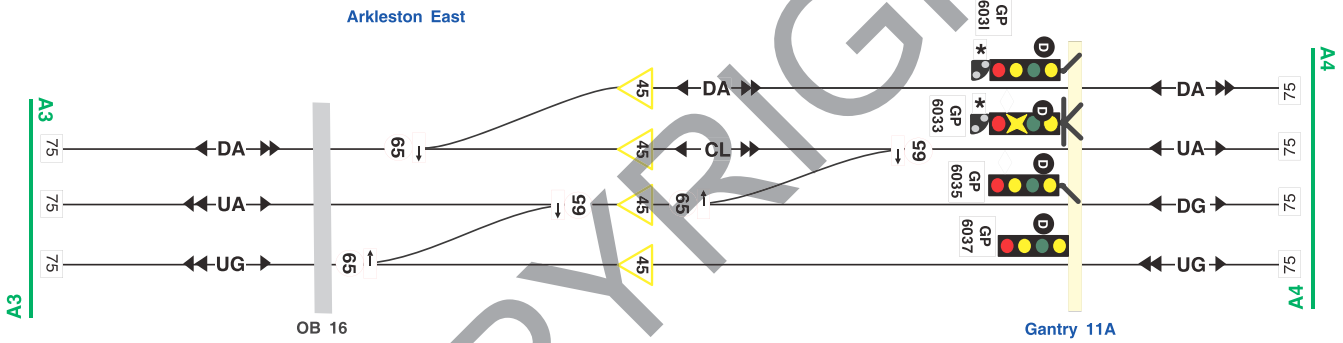

COPYRIGHT



- DA Down Ayr
- UA Up Ayr
- DG Down Gourrock
- UG Up Gourrock
- DGL Down Goods Loop

Note: **D** = LED Head Signal

\* = See Table of Routes

TCB  
 West of Scotland SC (GP)  
 AC: Cathcart ECR



7000 ↗ 2640

Note:  
 GP6038 is a right  
 hand side signal

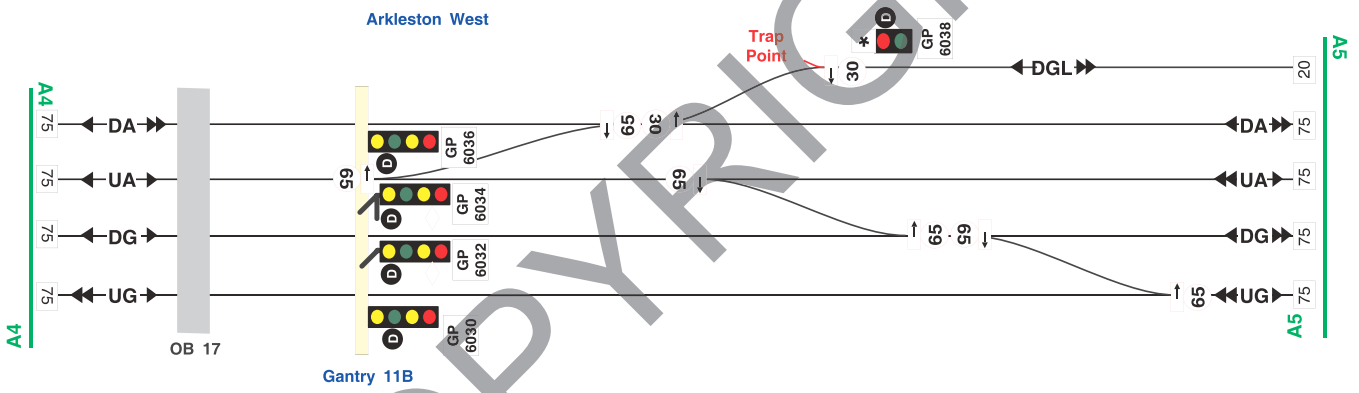

- DA Down Ayr
- UA Up Ayr
- DG Down Gourrock
- UG Up Gourrock
- DGL Down Goods Loop

Note: **D** = LED Head Signal

TCB  
 West of Scotland SC (GP)  
 AC: Cathcart ECR



6



DA Down Ayr  
 UA Up Ayr  
 DG Down Gourock  
 UG Up Gourock  
 DGL Down Goods Loop

Note: **D** = LED Head Signal

\* = See Table of Routes

TCB  
 West of Scotland SC (GP)  
 AC: Cathcart ECR

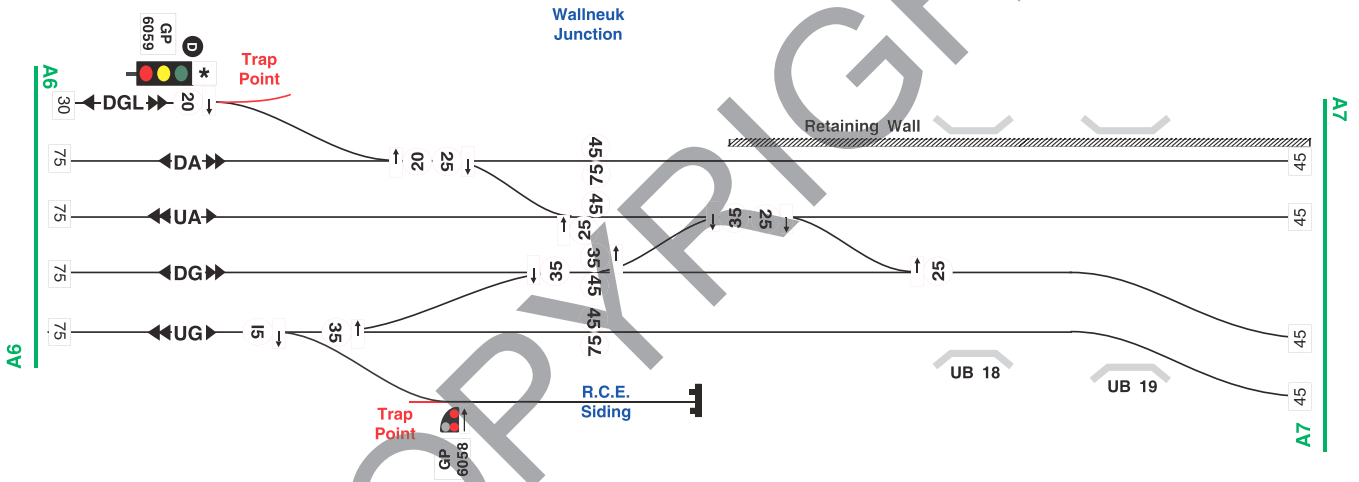

DA Down Ayr  
UA Up Ayr  
DG Down Gourock  
UG Up Gourock

Note: **D** = LED Head Signal  
\* = See Table of Routes

Mileage Change  
Ayr Lines  
6m 53ch. | 6m 73ch.

Mileage Change  
Gourock Lines  
6m 56ch. | 107m 69ch.

Note:  
GP6062, GP6063, GP6066,  
GP6067, GP6206, GP6209  
and GP6212  
are right hand side signals

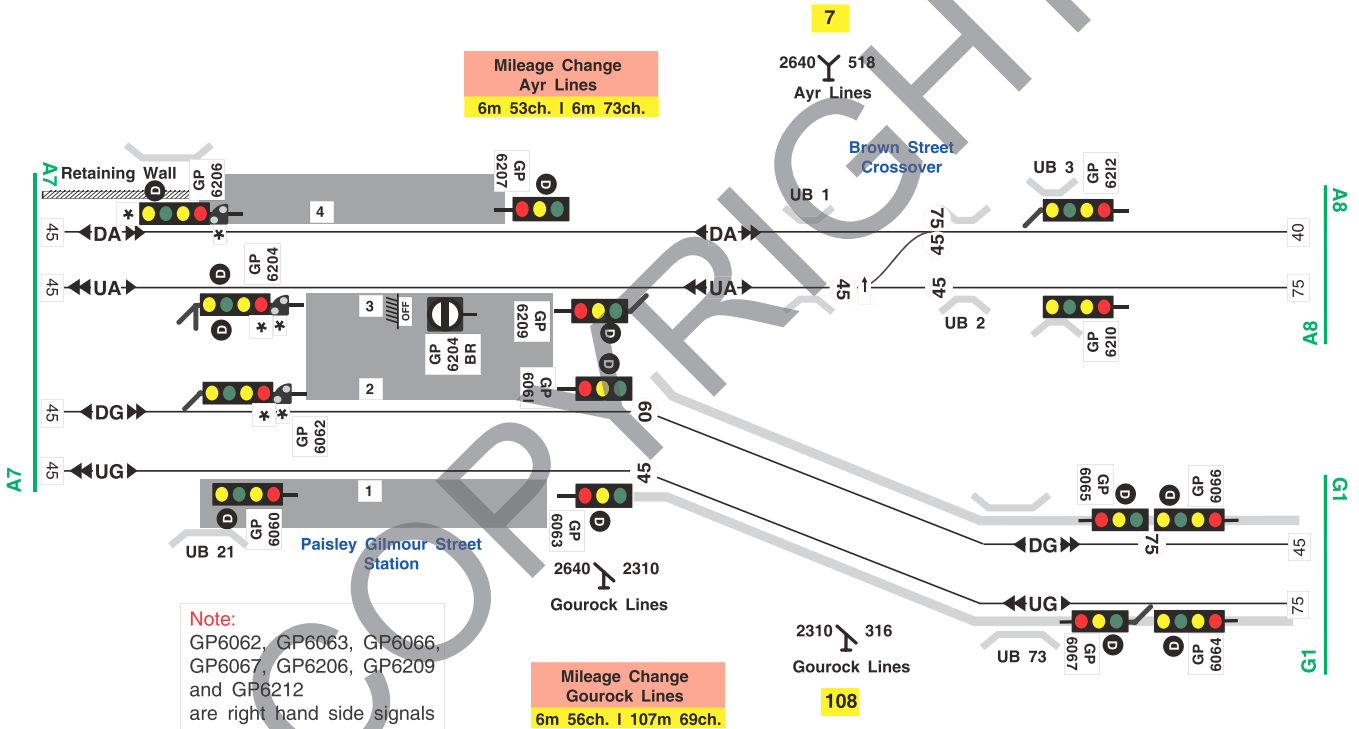

DA Down Ayr  
 UA Up Ayr  
 DG Down Gourouck  
 UG Up Gourouck

Note: **D** = LED Head Signal  
 \* = See Table of Routes

TCB  
 West of Scotland SC (GP)  
 AC: Cathcart ECR

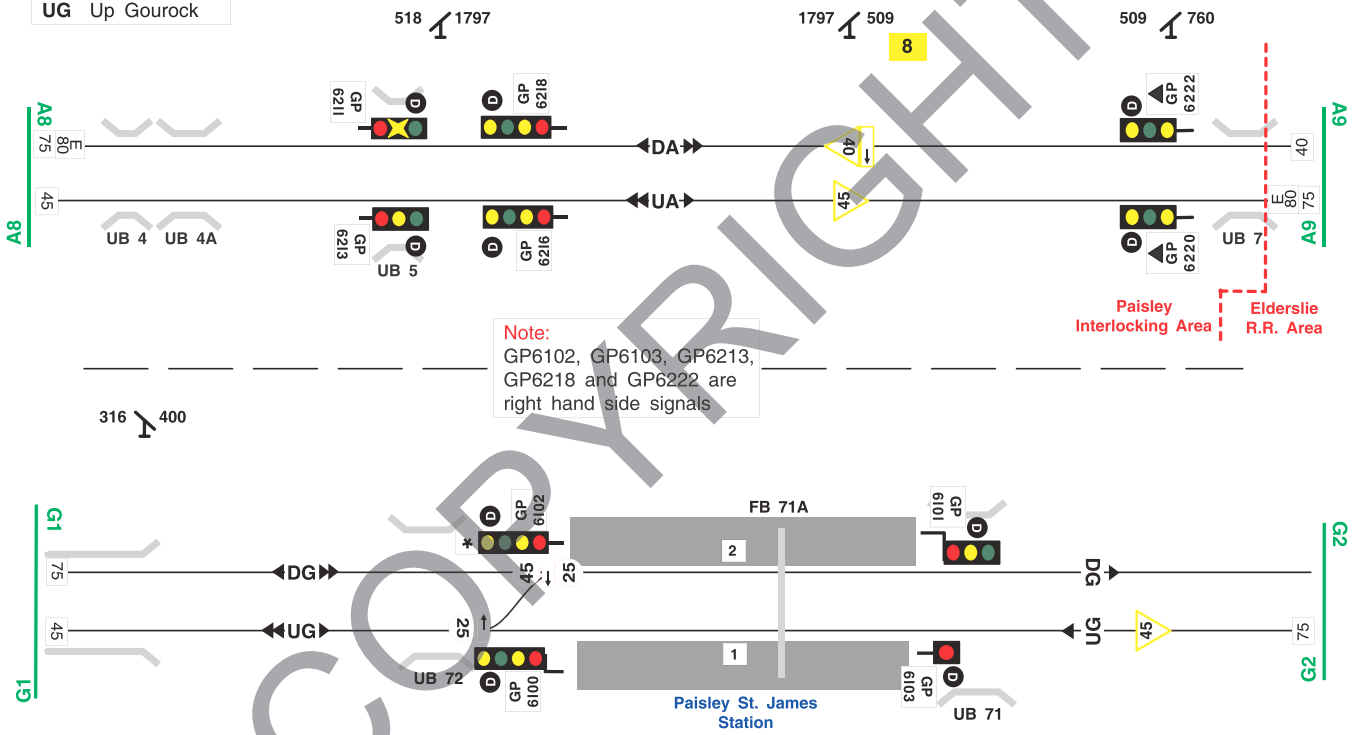

- DA** Down Ayr
- UA** Up Ayr
- DG** Down Gourrock
- UG** Up Gourrock
- UPL** Up Passenger Loop

**Note:** **D** = LED Head Signal

\* = See Table of Routes

TCB  
 West of Scotland SC (GP, GPE)  
 AC: Cathcart ECR

GSM-R

NRN

092

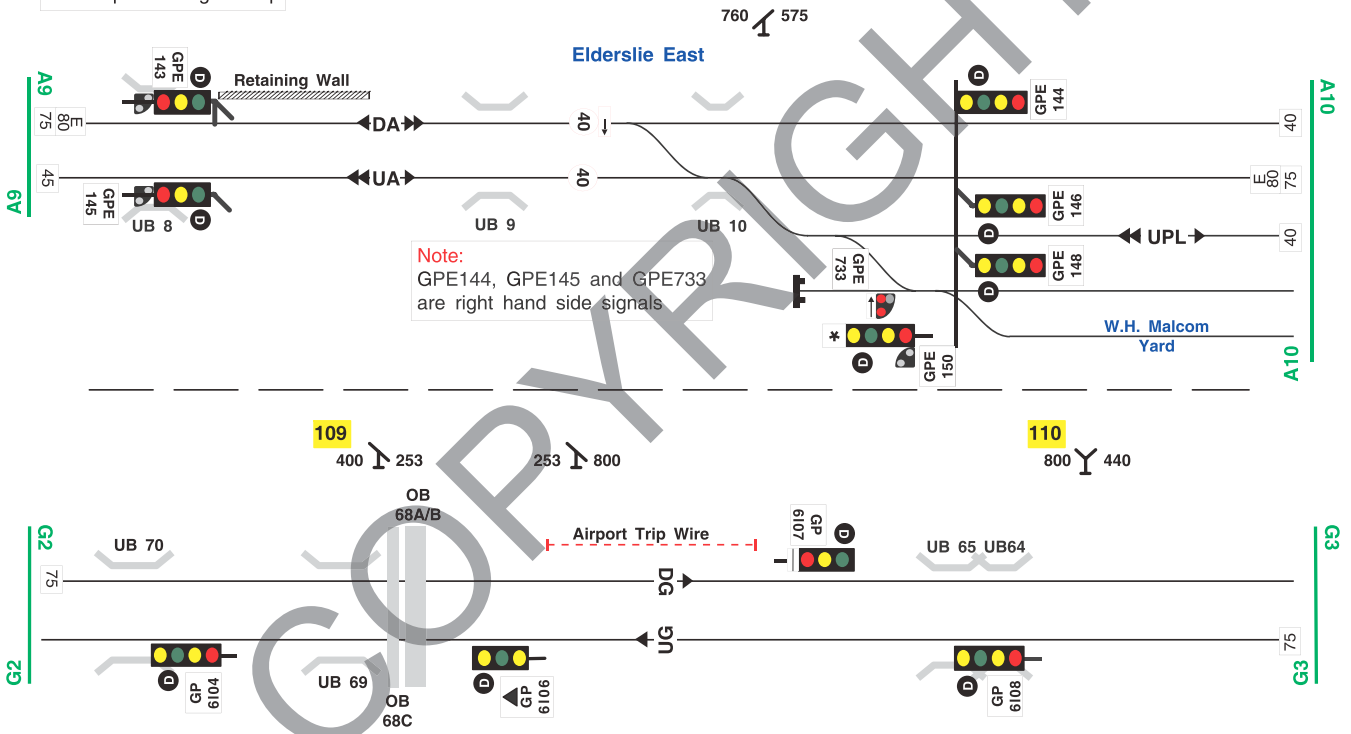

**Note:**  
 GPE144, GPE145 and GPE733  
 are right hand side signals

- DA Down Ayr
- UA Up Ayr
- DG Down Gourrock
- UG Up Gourrock
- UPL Up Passenger Loop

Note: **D** = LED Head Signal

TCB  
 West of Scotland SC (GP, GPE)  
 AC: Cathcart ECR

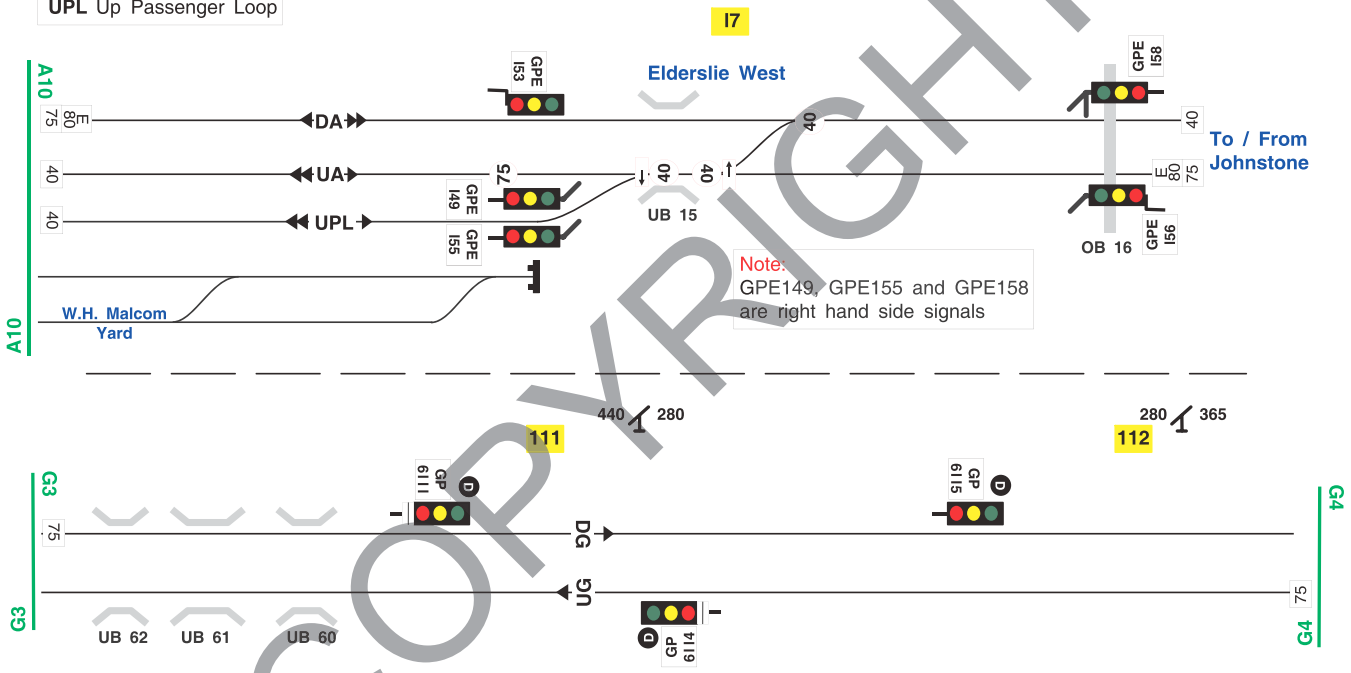

DG Down Gourrock  
UG Up Gourrock

Note: **D** = LED Head Signal

TCB  
West of Scotland SC (GP)  
AC: Cathcart ECR

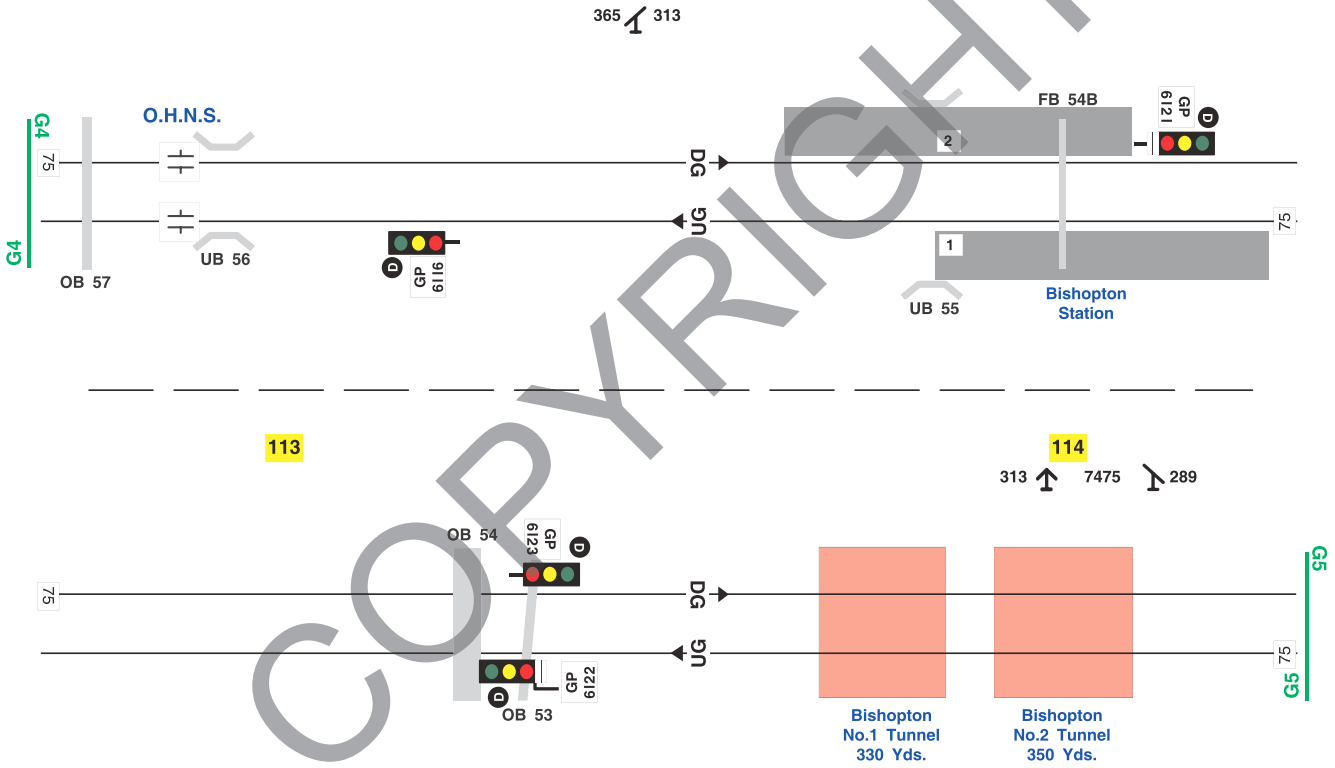



DG Down Gourrock  
UG Up Gourrock

Note: **D** = LED Head Signal

\* = See Table of Routes

TCB  
West of Scotland SC (GP)  
AC: Cathcart ECR

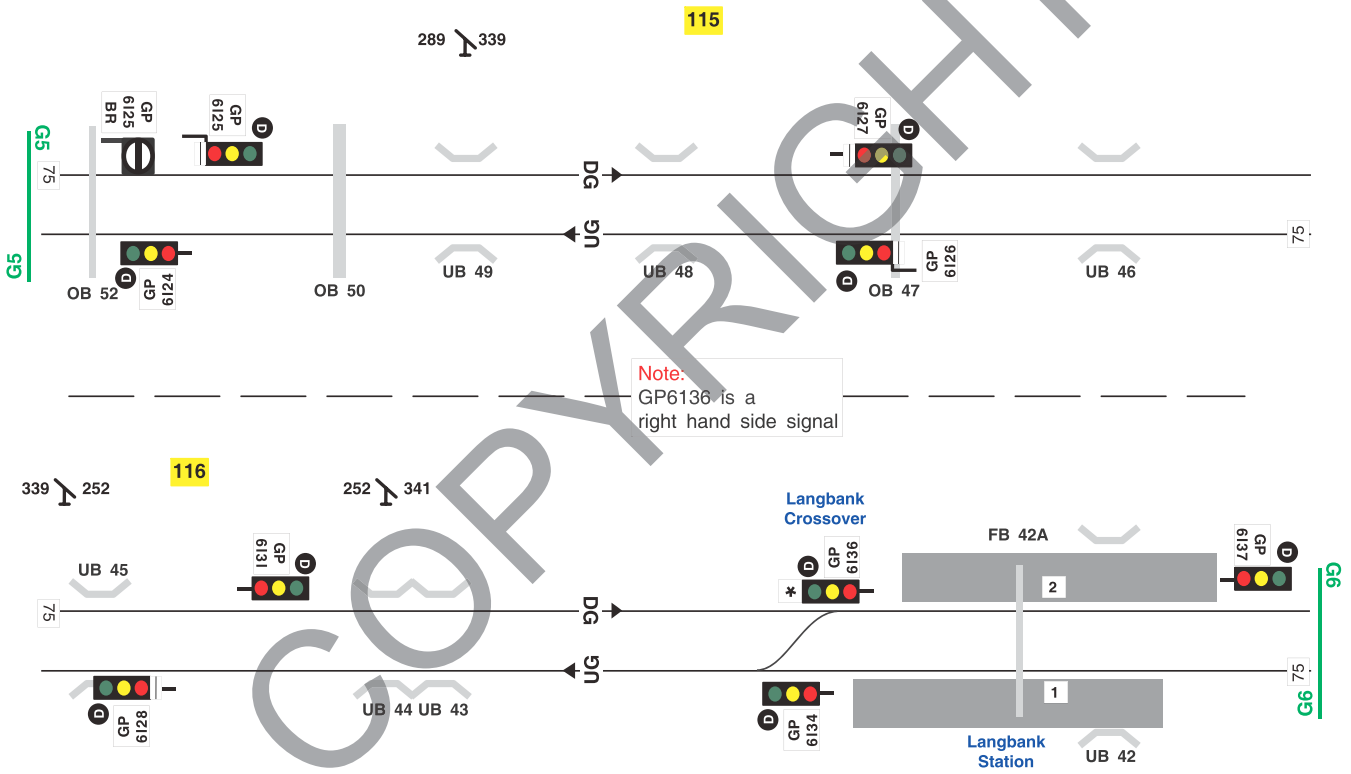

DG Down Gourrock  
UG Up Gourrock

Note: **D** = LED Head Signal

TCB  
West of Scotland SC (GP, GPL)  
AC: Cathcart ECR

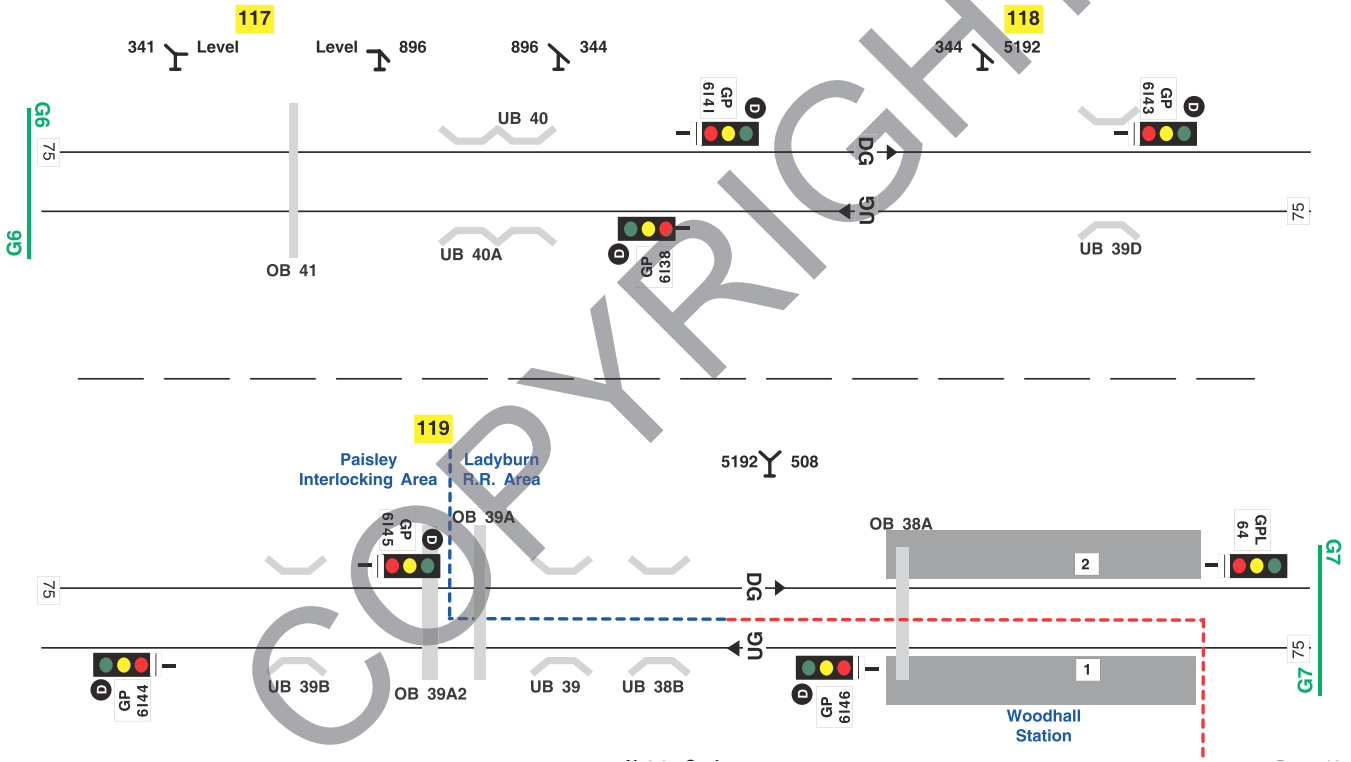

**DG** Down Gourock  
**UG** Up Gourock

**Note:** **D** = LED Head Signal

**TCB**  
**West of Scotland SC (GPL)**  
**AC: Cathcart ECR**

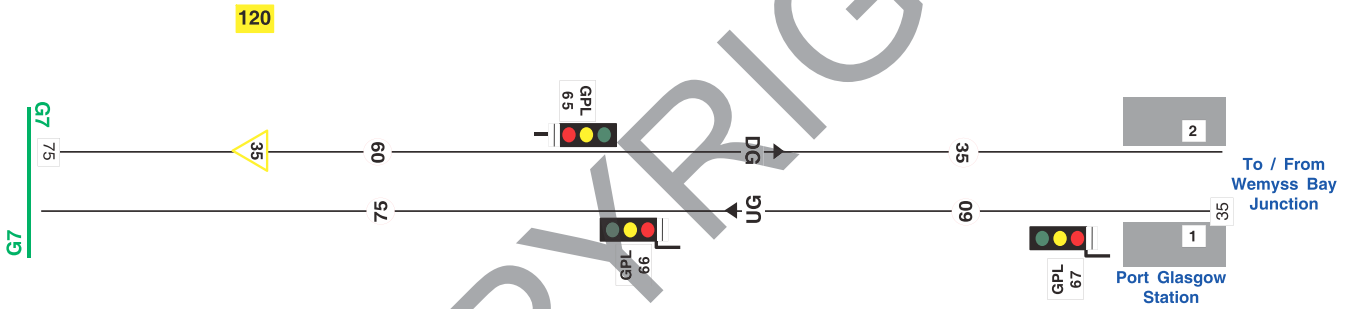

COPYRIGHT

# Table of Routes

The following lists of signal routes show all routes from

- signals from which there is more than one route
- signals which are capable of giving any route indications
- all position-light signals

## Down Direction – Ayr Lines

Signal Number	Aspect	Route Indication Displayed	Route	Exit Signal
GS 5903	M	Nil	Up Ayr	GS 5913
	M	Pos.4	Up Gourcock	GS 5915
	M	Pos.5	Down Deanside	GS 5907
GP 6021	M	Nil	Down Ayr	GP 6031
	M	Pos.4	Up Ayr	GP 6033
GP 6023	M	Pos.1	Up Ayr	GP 6033
	M	Nil	Down Gourcock	GP 6035
GP 6031	M	Pos.1	Down Goods Loop	GP 6059
	PL	DL	Down Goods Loop	–
	M	Nil	Down Ayr	GP 6051

'M' indicates a main aspect

'PL' indicates Position Light Shunt aspect

Items in the 'Route Indication Displayed' column specify a route indicator display or an illuminated Junction Indicator position

Signal Number	Aspect	Route Indication Displayed	Route	Exit Signal
GP 6033	M	Pos.2	Down Goods Loop	GP 6059
	PL	DL	Down Goods Loop	–
	M	Pos.1	Down Ayr	GP 6051
	M	Nil	Up Ayr	GP 6053
	M	Pos.4	Down Gourcock	GP 6055
	M	Pos.5	Up Gourcock	GP 6057
GP 6051	M	Nil	Down Ayr	GP 6207
	M	Pos.4	Up Ayr	GP 6209
	M	Pos.5	Down Gourcock	GP 6061
GP 6053	M	Nil	Up Ayr	GP 6209
	M	Pos.4	Down Gourcock	GP 6061
GP 6059	M	D	Down Ayr	GP 6207
	M	U	Up Ayr	GP 6209
	M	G	Down Gourcock	GP 6061
GP 6209	M	Pos.1	Down Ayr	GP 6211
	M	Nil	Up Ayr	GP 6213

### Down Direction – Ayr Lines continued

Signal Number	Aspect	Route Indication Displayed	Route	Exit Signal
GPE 143	M	Nil	Down Ayr	GPE 153
	M	Pos.4	Up Ayr	GPE 149
	M	Pos.5	Up Passenger Loop	GPE 155
	PL	Nil	W.H.M. Sidings	–
GPE 145	M	Nil	Up Ayr	GPE 149
	M	Pos.4	Up Passenger Loop	GPE 155
	PL	Nil	W.H.M. Sidings	–
GPE 733	PL	Nil	W.H.M. Sidings	–
GPE 149	M	Pos.1	Down Ayr	PE 159
	M	Nil	Up Ayr	PE 169
GPE 155	M	Pos.1	Down Ayr	PE 159
	M	Nil	Up Ayr	PE 169

### Down Direction – Gourock Lines

Signal Number	Aspect	Route Indication Displayed	Route	Exit Signal
GS 5905	M	Nil	Up Gourock	GS 5915
	M	Pos.4	Down Deanside	GS 5907
GP 6025	M	Pos.2	Up Ayr	GP 6033
	M	Pos.1	Down Gourock	GP 6035
GP 6035	M	Nil	Up Gourock	GP 6037
	M	Nil	Down Gourock	GP 6055
GP 6055	M	Pos.4	Up Gourock	GP 6057
	M	Pos.1	Up Ayr	GP 6209
GP 6057	M	Nil	Down Gourock	GP 6061
	M	Pos.2	Up Ayr	GP 6209
	M	Pos.1	Down Gourock	GP 6061
	M	Nil	Up Gourock	GP 6063
	PL	Nil	R.C.E. Siding	–
GP 6067	M	Pos.1	Down Gourock	GP 6101
	M	Nil	Up Gourock	GP 6103

## Up Direction – Ayr Lines

Signal Number	Aspect	Route Indication Displayed	Route	Exit Signal
GPE 158	M	Pos.2	Up Passenger Loop	GPE 148
	M	Pos.1	Up Ayr	GPE 146
	M	Nil	Down Ayr	GPE 144
GPE 156	M	Pos.1	Up Passenger Loop	GPE 148
	M	Nil	Up Ayr	GPE 146
GPE 150	PL	Nil	Headshunt	–
	M	U	Up Ayr	GP 6216
	M	D	Down Ayr	GP 6218
GPE 148	M	Nil	Up Ayr	GP 6216
	M	Pos.4	Down Ayr	GP 6218
GPE 146	M	Nil	Up Ayr	GP 6216
	M	Pos.4	Down Ayr	GP 6218
GP 6212	M	Pos.1	Up Ayr	GP 6204
	M	Nil	Down Ayr	GP 6206
GP 6206	M	D	Down Ayr	GP 6046
	M	L	Down Goods Loop	GP 6038
	PL	L	Down Goods Loop -	–

Signal Number	Aspect	Route Indication Displayed	Route	Exit Signal
GP 6204	M	Pos.2	Up Gourock	GP 6040
	M	Pos.1	Down Gourock	GP 6042
	M	Nil	Up Ayr	GP 6044
	M	D	Down Ayr	GP 6046
	M	L	Down Goods Loop	GP 6038
	PL	L	Down Goods Loop -	–
GP 6046	M	Pos.1	Up Ayr	GP 6034
	M	Nil	Down Ayr	GP 6036
GP 6038	M	U	Up Ayr	GP 6034
	M	D	Down Ayr	GP 6036
GP 6034	M	Pos.2	Up Gourock	GP 6020
	M	Pos.1	Up Ayr	GP 6022
	M	Nil	Down Ayr	GP 6024

## Up Direction – Gourock Lines

Signal Number	Aspect	Route Indication Displayed	Route	Exit Signal
GP 6136	M	U	Up Gourock	GP 6128
GP 6102	M	U	Up Gourock	GP 6064
	M	X	Down Gourock	GP 6066
GP 6062	M	Pos.1	Up Gourock	GP 6040
	M	Nil	Down Gourock	GP 6042
	M	U	Up Ayr	GP 6044
	M	D	Down Ayr	GP 6046
	M	L	Down Goods Loop	GP 6038
	PL	L	Down Goods Loop	–
GP 6058	PL	Nil	Up Gourock	GP 6040
GP 6040	M	Nil	Up Gourock	GP 6030
	M	Pos.4	Down Gourock	GP 6032
	M	Pos.5	Up Ayr	GP 6034
GP 6042	M	Nil	Down Gourock	GP 6032
	M	Pos.4	Up Ayr	GP 6034
GP 6032	M	Pos.1	Up Gourock	GP 6020
	M	Nil	Up Ayr	GP 6022
GS 5910	M	Nil	Up Gourock	GS 5900
	M	Pos.4	Up Ayr	GS 5902

COPYRIGHT

Gioconda Limited Unit 10 Woodfalls Gravelly Ways  
Laddingford Kent ME18 6DA

Telephone 01622 872512 email [mail@gioconda.co.uk](mailto:mail@gioconda.co.uk) [www.gioconda.co.uk](http://www.gioconda.co.uk)